



UNIDRIVE M200 & M300

Manufacturing Automation drives

Flexible machine integration through communications and enhance throughput with Machine Safety for open loop applications



- Unidrive M100
- Unidrive M200
- Unidrive M300
- Unidrive M400
- Unidrive M600
- Unidrive M700
- Unidrive M800

0.25 kW - 22 kW Heavy Duty
 (0.33 hp - 30 hp)
 100 V | 200 V | 400 V | 575 V



The Unidrive M Manufacturing Automation drive family

Unidrive M – A Manufacturing Automation drive family tailored to customer needs

Led by the results of extensive customer-driven market research, we have tailored seven Unidrive M feature-sets to specific application needs identified within Manufacturing Automation. The Unidrive M200 adds useful networking capability, additional I/O and improved motor control performance for open loop applications to the family. It also provides an easy upgrade for existing Commander SK users. The Unidrive M300 adds integrated Machine Safety for open loop applications.

For more information on the full Unidrive M family, please download the Unidrive M Overview brochure or the 'Discover Unidrive M' App (available on the App Store, Android and online) via www.UnidriveM.com.



Unidrive M200 and M300 features

M201 variant has additional speed reference potentiometer

Optional AI-485 Adaptor for RS485 communications

Optional AI-Back-up Adaptor allows the drive to use an SD card for parameter cloning and acts as an input for 24 V back-up

LED keypad fitted as standard for quick commissioning and easy use

Optional IP66 rated Remote keypad also available with intuitive plain text multilingual back-lit LCD display for rapid set-up and superior diagnostics

Dual onboard Safe Torque Off (STO) terminals for easy SIL3 conformity (M300 only)

Conventional surface and DIN rail mounting (DIN rail mounting available on size 1 and 2 only)

User-friendly control connections

Drive rated to IP21 / UL open class (NEMA 1) on size 1 to 4 as standard

Conduit kits are available to meet UL Type 1 rating

Easy-to-remove terminal cover with tool-less close system (patent pending)

Typical System Integration (SI) option module

System Integration (SI) module slot for communications and additional I/O

Easy-to-disconnect internal EMC filter*

User-friendly power connections*

Robust cable management system providing grounding point for shielded control and power cables

*Features and their locations vary on some drive sizes

Unidrive M200 and M300 AC drives at a glance:

Unidrive M200

Flexible machine integration through communications

M200 delivers substantial communication and application integration through optional RS485 plus a wide range of industry standard fieldbus and I/O SI modules. Enhances machine up-time and performance with its remote control monitoring and diagnostics possibilities.

Unidrive M300

Enhance throughput with Machine Safety

M300 helps machine builders maximize up-time and meet modern functional safety standards. Dual onboard Safe Torque Off (STO) inputs offer easy SIL3 conformity and reduce the need for external components, minimizing overall machine dimensions and costs.



Enhance productivity through easy integration with automation systems and reduce machine downtime

Unidrive M200 and M300 provide optional RS485 communications and a port for a System Integration (SI) option module. SI modules include Ethernet, EtherCAT, PROFIBUS, DeviceNet and CANopen network communications, and additional I/O. These allow remote control and diagnostics across different networks.

Maximize throughput and easily meet machine safety requirements

Unidrive M300 has onboard dual Safe Torque Off (STO) inputs for easy safety system integration, eliminating external components such as contactors. Compliance with SIL3 is simple while machine productivity is enhanced.

Maximize productivity with high performance control of AC motors

Unidrive M200 and M300's advanced RFC control algorithm ensures maximum stability and machine control. It provides a

high bandwidth motor control algorithm with 166 μ s current loop update rates and 180 % motor overload for heavy industrial machinery applications.

Robust design

Using extensive customer research, Unidrive M200 and M300 have been designed and tested for leading reliability in manufacturing environments. It features:

- Unique advanced cooling design featuring a patented flow system that helps cool the drive more effectively while protecting internal components
- Conformally coated PCBs
- 180 % overload for 3 s or 150 % for 60 s
- Wide supply voltage tolerance
- Drive meets IP21 as standard
- Higher temperature operation with de-rating
- Intelligent 3 speed user-replaceable cooling fan with patented fan-fail detection circuit



Quick and easy to install and configure

Unidrive M200 and M300 have a fixed LED keypad as standard and the 10 most commonly used parameters listed on the front of the drive. Software tools, alternative keypads and memory storage devices provide easy and fast access to Unidrive M's machine control features for configuration, monitoring and diagnostics.

Fast parameter transfer without mains power

For fast, serial machine production the AI-Back-up Adaptor option plugs into the top of the drive to allow configuration settings to be copied without the need to apply mains power. Files are stored on an SD memory card for easy handling.

Reduce machine size and cost

Unidrive M200 and M300's compact drive dimensions are among the smallest in class at every power rating. They provide a powerful and economical Manufacturing Automation solution.

Powerful and easy field service and upgrade

The M200 is designed to extend the field service life of previous

generations of products by providing the easiest possible upgrade for OEM machine designs and end user installations which currently use Commander SK drives. Upgrade features include:

- Compatible dimensions
- Support for the import of Commander SK parameter files and drive cloning

Typical applications:

M200: Speed control for conveyors, fans, positive displacement pumps and mixers, where their functions are controlled remotely via fieldbus or Ethernet communications.

M300: Speed control for material transport and cutting, woodworking and machine tools where protection to people or assets is required to SIL3.





Pharmaceutical mixer granulator

Power System Flexibility

Unidrive M's power stage enhances flexibility and energy efficiency :

- Low losses, up to 98 % efficient.
- Low power standby mode. In some applications, drives can sit idle for significant periods; M200 and M300's reduced standby power saves energy.
- Intelligently controlled 3-speed cooling fan adjusts to the motor load and environmental conditions. This results in power saving, extended fan life and reduced acoustic noise.
- Silent motor operation with high PWM switching frequencies up to 16 kHz.

Motor control modes include:

Control Mode	Features
Open loop vector or V/Hz induction motor control	Open loop motor control for induction motors, providing good performance and the easiest configuration. V/Hz can be used in multi-motor systems.
Enhanced open loop Rotor Flux Control for induction motors (RFC-A)	High performance speed and torque control through an advanced vector algorithm, utilizing current feedback to greatly enhance performance for all induction motor sizes without the need for a feedback device.



Extensive testing has confirmed that Unidrive M's many innovative and protective design features have enhanced reliability in the most challenging of Manufacturing Automation environments and extended product lifetime.

Material handling application

Unidrive M200 and M300 option choices and terminal layout

Control Mode

1. Open loop vector or V/Hz induction motor control
2. Open loop Rotor Flux Control for induction motors (RFC-A)



Input/Output

SI-I/O



- 4 x Digital I/O
- 3 x Analog input (default) / Digital input
- 1 x Analog output (default) / Digital input
- 2 x Relay

Standard



- 3 x Analog I/O
- 5 x Digital I/O
- 2 x STO (M300 only)
- 1 x Relay (size 1 to 4)
- 2 x Relay (size 5 to 9)

Communications

AI-485 Adaptor



SI-EtherCAT



SI-PROFIBUS



SI-Ethernet



SI-DeviceNet



SI-CANopen



DC back up power supply



AI-Back-up Adaptor
(Input for 24 V back-up)

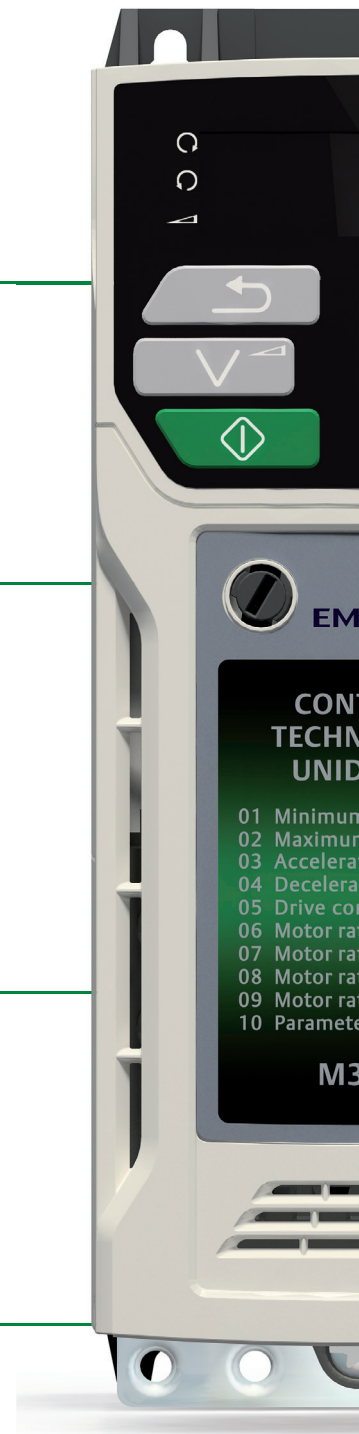



Optional Drive Programming and Operator Interface

Unidrive M Connect



Fixed LED keypad



M201 - Fixed LED keypad with speed reference potentiometer



Operator Interface



AI-Back-up Adaptor (provides SD card usage)



Remote Keypad (LCD)



Terminal Layout

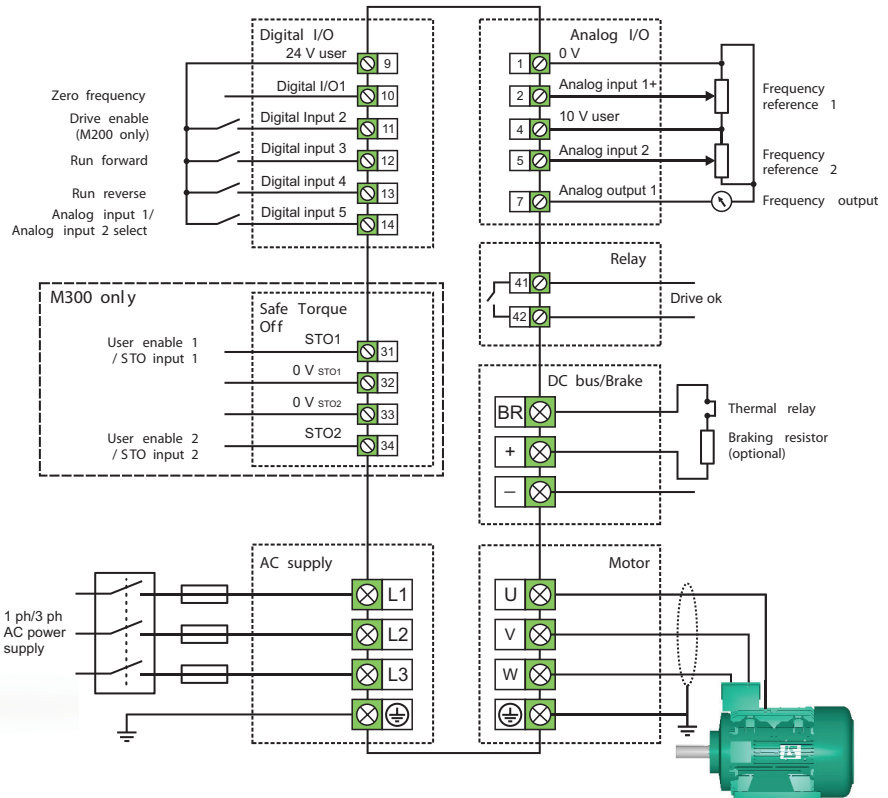





Wood cutting at furniture manufacturer

Fast and Easy access for Commissioning, Monitoring and Diagnostics
 Unidrive M keypads, memory devices and software tools make it easy to access Unidrive M200 and M300's full feature set, allowing users to optimize drive tuning, back-up the configuration set and troubleshoot more quickly.

User interface options

Unidrive M benefits from a number of optional keypad choices to meet your application needs.

Type		Benefit
Fixed LED keypad (M200 and M300)		Simple LED keypad fitted as standard for quick and easy commissioning and use.
Fixed LED keypad with speed reference potentiometer (M201)		Simple LED keypad with user friendly speed reference potentiometer for quick and easy commissioning and use.
Remote Keypad (All)		Remote mountable, intuitive plain text, multi-language LCD keypad for rapid set-up and superior diagnostics (using the AI-485 Adaptor along with a common comms lead). Rated to IP66.

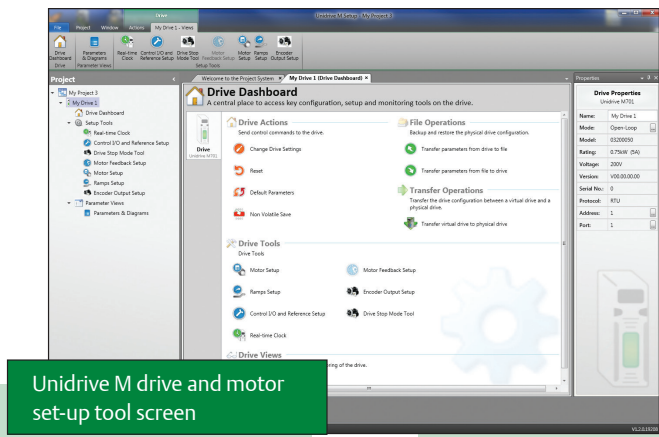

Unidrive M Connect commissioning tool

Based on Control Techniques' 25 years of experience, Unidrive M Connect is our latest drive configuration tool for commissioning, optimizing and monitoring drive/system performance. Its development draws from extensive user research, using human centered design principles to give the ultimate user experience:

- Fast task based commissioning and easy maintenance of the Unidrive M family is simplified via familiar Windows interface
- Intuitive graphical tools enhance and simplify user experience
- For experienced users, dynamic drive logic diagrams and enhanced searchable listings are present
- Drive and motor performance can be optimized with minimal specialized drive knowledge
- Tool is scalable to match application requirements
- Supports the import of Commander SK parameter files and allows full drive cloning (i.e. parameter sets and application program)
- Multiple simultaneous communications channels for a more complete overview of the system
- Drive discovery gives the ability to find drives on a network automatically without the user having to specify their addresses
- Automatic RTU baud rate scanning on the M200 and M300 RS485 connection

Portable SD memory card

Unidrive M200 and M300 uses popular SD cards for quick and easy parameter and program storage using the AI-Back-up Adaptor. SD cards provide a huge memory capability allowing a complete system reload if required and can be easily pre-programmed on a common PC.

Performance motor control

Control Techniques' unique motor control algorithms combined with the latest microprocessor technology ensure that Unidrive M200 and M300 offers high stability and bandwidth for many industrial motor types. This enables you to maximize machine throughput and efficiency in every application using open loop AC induction motors.

Unidrive M200 and M300 feature and specification table

Performance	Current loop update: 166 µs
	Heavy Duty peak rating: 180 % (3 s), 150 % (60 s)
	Maximum output frequency: 550 Hz
	Switching frequency range: 0.67, 1, 2, 3, 4, 6, 8, 12, 16 kHz (3 kHz default)
Mechanical attributes	DIN rail mountable (size 1 and 2)
	Commander SK compatible mechanical footprint either as standard or with conversion plates
Parameter back-up	Serial port cloning (using optional AI-485 Adaptor)
	SD card (using optional AI-Back-up Adaptor)
Onboard I/O	2 x Analog inputs, 1 x Analog output
	4 x Digital inputs, 1 x Bidirectional digital input or output
	1 x Relay output (size 1 to 4), 2 x Relay outputs (size 5 and 6)
Machine safety	2 x Safe Torque Off (STO) inputs (M300 only)
Back-up power	24 V control back-up (using optional AI-Back-up Adaptor)
Other	Temperature controlled fan with standby (off)
	User replaceable fan(s)
	Conformal coating
	Standby mode (energy saving)
	User defined security levels (e.g. restricted access or read-only parameters via user defined security code)

Unidrive M200 and M300 ratings and specifications

100/120 Vac ±10 %							
Order Code	Supply Phases	Heavy Duty			Normal Duty		
		Max Continuous Current (A)	Motor Shaft Power (kW)	Motor Shaft Power (HP)	Max Continuous Current (A)	Motor Shaft Power (kW)	Motor Shaft Power (HP)
Mx0x-011 00017	1	1.7	0.25	0.33	For Normal Duty applications, use Heavy Duty ratings.		
Mx0x-011 00024	1	2.4	0.37	0.5			
Mx0x-021 00042	1	4.2	0.75	1			
Mx0x-021 00056	1	5.6	1.1	1.5			

200/240 Vac ±10 %							
Order Code	Supply Phases	Heavy Duty			Normal Duty		
		Max Continuous Current (A)	Motor Shaft Power (kW)	Motor Shaft Power (HP)	Max Continuous Current (A)	Motor Shaft Power (kW)	Motor Shaft Power (HP)
Mx0x-012 00017	1	1.7	0.25	0.33	For Normal Duty applications, use Heavy Duty ratings.		
Mx0x-012 00024	1	2.4	0.37	0.5			
Mx0x-012 00033	1	3.3	0.55	0.75			
Mx0x-012 00042	1	4.2	0.75	1			
Mx0x-022 00024	1/3	2.4	0.37	0.5			
Mx0x-022 00033	1/3	3.3	0.55	0.75			
Mx0x-022 00042	1/3	4.2	0.75	1			
Mx0x-022 00056	1/3	5.6	1.1	1.5			
Mx0x-022 00075	1/3	7.5	1.5	2			
Mx0x-032 00100	1/3	10	2.2	3			
Mx0x-042 00133	1/3	13.3	3	3			
Mx0x-042 00176	3	17.6	4	5			
Mx0x-052 00250	3	25	5.5	7.5			
Mx0x-062 00330	3	33	7.5	10	50	11	15
Mx0x-062 00440	3	44	11	15	58	15	20

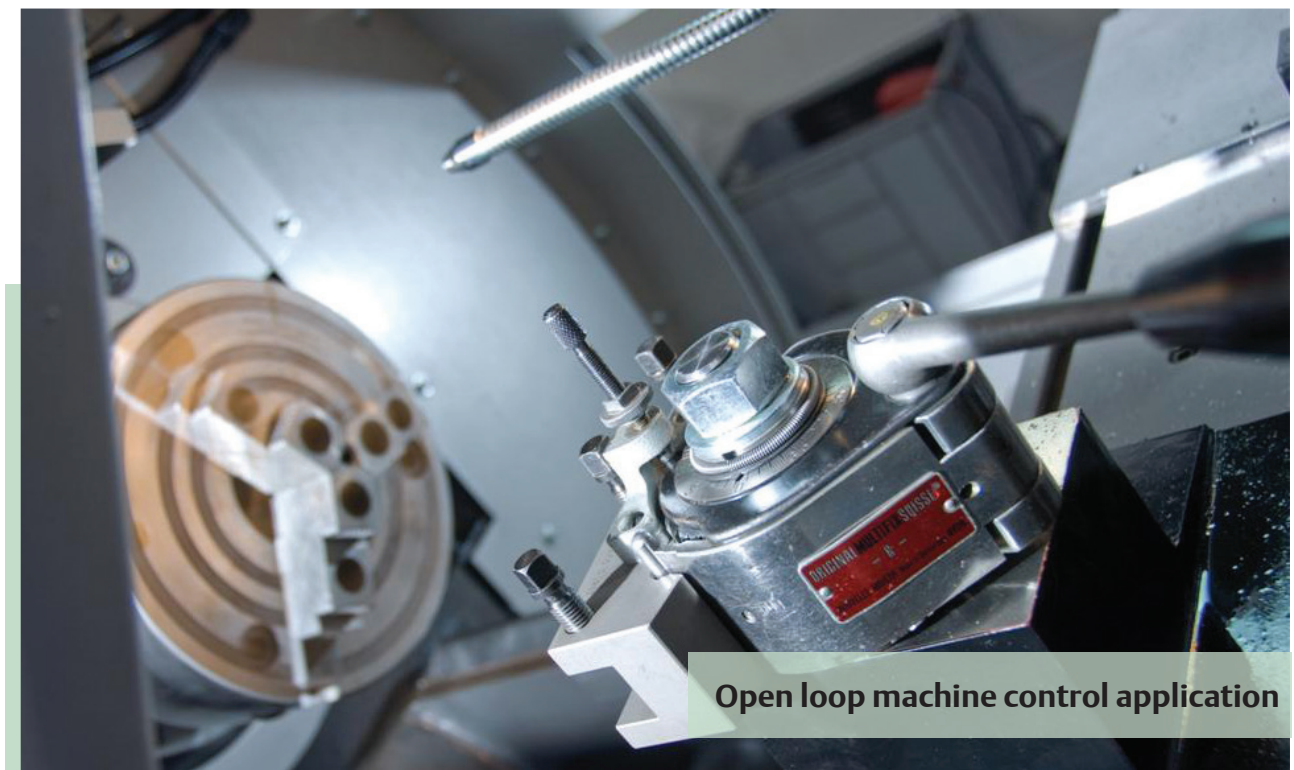

Open loop machine control application

380/480 Vac ±10 %							
Order Code	Supply Phases	Heavy Duty			Normal Duty		
		Max Continuous Current (A)	Motor Shaft Power (kW)	Motor Shaft Power (HP)	Max Continuous Current (A)	Motor Shaft Power (kW)	Motor Shaft Power (HP)
Mx0x-024 00013	3	1.3	0.37	0.5	For Normal Duty applications, use Heavy Duty ratings.		
Mx0x-024 00018	3	1.8	0.55	0.75			
Mx0x-024 00023	3	2.3	0.75	1			
Mx0x-024 00032	3	3.2	1.1	1.5			
Mx0x-024 00041	3	4.1	1.5	2			
Mx0x-034 00056	3	5.6	2.2	3			
Mx0x-034 00073	3	7.3	3	3			
Mx0x-034 00094	3	9.4	4	5			
Mx0x-044 00135	3	13.5	5.5	7.5			
Mx0x-044 00170	3	17	7.5	10			
Mx0x-054 00270	3	27	11	20		30	15
Mx0x-054 00300	3	30	15	20	30	15	20
Mx0x-064 00350	3	35	15	25	38	18.5	25
Mx0x-064 00420	3	42	18.5	30	48	22	30
Mx0x-064 00470	3	47	22	30	63	30	40

500/575 Vac ±10 %							
Drive	Supply Phases	Heavy Duty			Normal Duty		
		Max Continuous Current (A)	Typical Output (kW)	Motor Power (HP)	Max Continuous Current (A)	Typical Output (kW)	Motor Power (HP)
Mx0x-055 00030 A	3	3	1.5	2	3.9	2.2	3
Mx0x-055 00040 A	3	4	2.2	3	6.1	4	5
Mx0x-055 00069 A	3	6.9	4	5	10	5.5	7.5
Mx0x-065 00100 A	3	10	5.5	7.5	12	7.5	10
Mx0x-065 00150 A	3	15	7.5	10	17	11	15
Mx0x-065 00190 A	3	19	11	15	22	15	20
Mx0x-065 00230 A	3	23	15	20	27	18.5	25
Mx0x-065 00290 A	3	29	18.5	25	34	22	30
Mx0x-065 00350 A	3	35	22	30	43	30	40

Heavy Duty

Suitable for demanding applications, current overload of 180 % (3 s) is available for dynamic loads.

Normal Duty

Suitable for most applications, with a current overload capacity of 110 %.

Key:

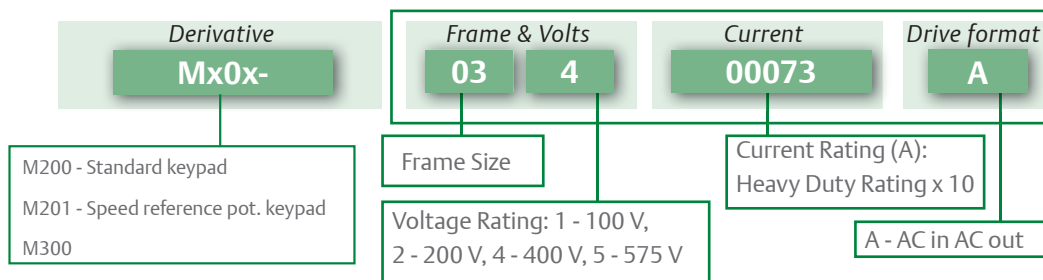

Unidrive M200 and M300 ratings and specifications

Environmental safety and electrical conformance

- Size 1 to 4: IP21 / UL open class (NEMA 1).
IP20 when the AI-Back-up or AI-485 Adaptors are fitted.
UL TYPE 1 compliance requires the appropriate Conduit kit to be fitted.
- Size 5 to 9: IP20 / UL open class (NEMA 1).
UL TYPE 1 compliance requires the appropriate Conduit kit to be fitted.
IP65 / UL TYPE 12 rating is achieved on the rear of the drive when through panel mounted.
- Ambient temperature -20 °C (-4 °F) to 40 °C (104 °F) as standard.
Up to 60 °C (140 °F) with derating.
- Storage temperature -40 °C to 60 °C (-40 °F to 140 °F).
- Humidity 95 % maximum (non-condensing) at 40 °C (104 °F) in accordance with EN/IEC 60068-2-78 and ANSI/EIA-364-31.
- EN/IEC 60068-2-60, Method 4 Corrosive gas.
- Altitude: 0 to 3000 m (0 to 9843 ft), derate 1 % per 100 m (328 ft) between 1000 m and 3000 m (3281 ft and 9843 ft).
- Random Vibration: Tested in accordance with EN/IEC 60068-2-64 with SI and AI option modules fitted.
- Mechanical Shock: Tested in accordance with EN/IEC 60068-2-29.
- Electromagnetic Immunity complies with EN/IEC 61800-3 and EN/IEC 61000-6-2.
- With onboard EMC filter, complies with EN/IEC 61800-3 (2nd environment).
- EN/IEC 61000-6-3 and EN/IEC 61000-6-4 with optional footprint EMC filter.
- EN/IEC 60146-1-1 Supply conditions.
- EN/IEC 61800-5-1 Electrical Safety.
- EN/IEC 61131-2 I/O.
- Safe Torque Off, independently assessed by TÜV to EN/IEC 61800-5-2 SIL 3 and EN ISO 13849-1 PL e.
- UL 508C Electrical Safety.

Dimensions and Weight



Frame Size		1	2	3	4	5	6
Dimensions (H x W x D)	mm	137 x 75 x 130	180 x 75 x 150	200 x 90 x 160	245 x 115 x 175	379 x 141 x 200	379 x 210 x 227
	in	5.4 x 3.0 x 5.1	7.1 x 3.0 x 5.9	7.9 x 3.5 x 6.3	9.7 x 4.5 x 6.9	14.9 x 5.6 x 7.9	14.9 x 8.3 x 8.9
Weight	kg (lb)	0.75 (1.65)	1.0 (2.2)	1.5 (3.3)	3.13 (6.9)	7.4 (16.3)	14 (30.9)

Notes:

Height dimension (H) does not include mounting feet on sizes 1 to 4.

Additional distance should be added to the height dimension (H) when the following options are fitted:

- AI-Back-up Adaptor: 15 mm (0.59 in)
- AI-485 Adaptor: 26 mm (1.02 in)

Optional keypad

Description	Order code
Remote Keypad	82500000000001

Optional accessories

Description	Order code
AI-Back-up Adaptor	82500000000004
AI-485 Adaptor	82500000000003

Conduit kit

When the following kits are fitted to the drive, it meets UL Type 1.

Frame size	Order code
1	3470-0091
2	3470-0094
3	3470-0098
4	3470-0102
5	3470-0069
6	3470-0059

Internal brake resistor

Frame size	Order code
5	1299-0003

Through hole kit

IP65 / UL TYPE 12 rating is achieved on the rear of the drive when through panel mounted using the following kits.

Frame size	Order code
5	3470-0067
6	3470-0055

Retrofit mounting brackets

These mounting brackets ensure the drive can be mounted on existing Commander SK installations.

Frame size	Order code
3	3470-0097
4	3470-0101

Fan replacement kit

Frame size	Order code
1	3470-0092
2	3470-0095
3	3470-0099
4	3470-0103

Optional external EMC filters

Unidrive M built-in EMC filter complies with EN/IEC 61800-3. External EMC filters are required for compliance with EN/IEC 61000-6-4 as per the table below.

Frame size	Voltage	Phases	Type	Order code
1	All	1	Standard	4200-1000
		1	Low leakage	4200-1001
2	100 V	1	Standard	4200-2000
		1	Standard	4200-2001
	200 V	1	Low leakage	4200-2002
		3	Standard	4200-2003
		3	Low leakage	4200-2004
		3	Standard	4200-2005
400 V	3	Low leakage	4200-2006	
	200 V	1	Standard	4200-3000
1		Low leakage	4200-3001	
3		Standard	4200-3004	
3		Low leakage	4200-3005	
400 V	3	Standard	4200-3008	
	3	Low leakage	4200-3009	
4	200 V	1	Standard	4200-4000
		1	Low leakage	4200-4001
		3	Standard	4200-4002
		3	Low leakage	4200-4003
	400 V	3	Standard	4200-4004
		3	Low leakage	4200-4005
5	200 V	3	Standard	4200-0312
	400 V	3	Standard	4200-0402
	575 V	3	Standard	4200-0122
6	200 V	3	Standard	4200-2300
	400 V	3	Standard	4200-4800
	575 V	3	Standard	4200-3690

For a full list of patents and patent applications, visit www.controltechniques.com/patents.

CONTROL TECHNIQUES DRIVE & APPLICATION CENTERS

AUSTRALIA

Melbourne Application Center
T: +613 973 81777
controltechniques.au@emerson.com

Sydney Drive Center
T: +61 2 9838 7222
controltechniques.au@emerson.com

AUSTRIA

Linz Drive Center
T: +43 7229 789480
controltechniques.at@emerson.com

BELGIUM

Brussels Drive Center
T: +32 1574 0700
controltechniques.be@emerson.com

BRAZIL

Sorocaba Drive Center
T: +55 15 3413 8169
vendabrasil.cta@emerson.com

CANADA

Toronto Application Center
T: +1 905 948 3402
controltechniques.ca@emerson.com

Calgary Drive Center
T: +1 403 253 8738
controltechniques.ca@emerson.com

CHILE

Santiago Application Center
T: +56 9 7708 9470
saleschile.cta@emerson.com

CHINA

Shanghai Drive Center
T: +86 21 3418 3888
controltechniques.cn@emerson.com

Shenzhen Application Center
T: +86 755 8618 7287
controltechniques.cn@emerson.com

CZECH REPUBLIC

Brno Drive Center
T: +420 511 180111
controltechniques.cz@emerson.com

DENMARK

Copenhagen Drive Center
T: +45 4369 6100
controltechniques.dk@emerson.com

FRANCE*

Angoulême Drive Center
T: +33 5 4564 5454
controltechniques.fr@emerson.com

GERMANY

Bonn Drive Center
T: +49 2242 8770
controltechniques.de@emerson.com

Chemnitz Drive Center
T: +49 3722 52030
controltechniques.de@emerson.com

Darmstadt Drive Center
T: +49 6251 17700
controltechniques.de@emerson.com

GREECE*

Athens Application Center
T: +0030 210 57 86086/088
controltechniques.gr@emerson.com

HOLLAND

Rotterdam Drive Center
T: +31 184 420555
controltechniques.nl@emerson.com

INDIA

Chennai Drive Center
T: +91 44 2496 1123/1130/1083
T: +91 44 6691 8400
controltechniques.in@emerson.com

IRELAND

Newbridge Drive Center
T: +353 45 448200
controltechniques.ie@emerson.com

ITALY

Milan Drive Center
T: +39 02575 751
controltechniques.it@emerson.com

Vicenza Drive Center
T: +39 0444 933400
controltechniques.it@emerson.com

MALAYSIA

Selangor Drive Center
T: +603 5891 6099
controltechniques.my@emerson.com

MEXICO

Mexico City Application Center
T: +52 155 3333 6666
salesmexico.cta@emerson.com

POLAND

Warsaw Application Center
T: +48 22 45 89 200
controltechniques.pl@emerson.com

REPUBLIC OF SOUTH AFRICA

Johannesburg Drive Center
T: +27 11 462 1740
controltechniques.za@emerson.com

Cape Town Application Center
T: +27 21 556 0245
controltechniques.za@emerson.com

RUSSIA

Moscow Application Center
T: +7 495 981 9811
controltechniques.ru@emerson.com

SINGAPORE

Singapore Drive Center
T: +65 6556 1100
controltechniques.sg@emerson.com

SLOVAKIA EMERSON A.S

T: +421 32 7700 369
controltechniques.sk@emerson.com

SOUTH KOREA

Seoul Application Center
T: +82 2 3483 1605
controltechniques.kr@emerson.com

SPAIN

Barcelona Drive Center
T: +34 93 680 1661
controltechniques.es@emerson.com

Bilbao Drive Center
T: +34 94 620 3646
controltechniques.es@emerson.com

Madrid Application Center
T: +34 91 490 21 05
controltechniques.es@emerson.com

Valencia Drive Center
T: +34 96 154 2900
controltechniques.es@emerson.com

SWEDEN*

Stockholm Application Center
T: +468 554 241 00
controltechniques.se@emerson.com

SWITZERLAND

Zurich Drive Center
T: +41 56 201 4242
controltechniques.ch@emerson.com

Lausanne Application Center
T: +41 21 637 7070
controltechniques.fr.ch@emerson.com

TAIWAN

Taipei Application Center
T: +886 2 8161 7695
controltechniques.tw@emerson.com

THAILAND

Bangkok Drive Center
T: +66 2 962 2099
controltechniques.th@emerson.com

TURKEY

Istanbul Drive Center
T: +90 216 4182420
controltechniques.tr@emerson.com

UAE*

Emerson FZE
T: +971 4 8118100
ct.dubai@emerson.com

UNITED KINGDOM
Telford Drive Center
T: +44 1952 213700
controltechniques.uk@emerson.com

USA

Charlotte Application Center
T: +1 800 893 2321
controltechniques.us@emerson.com

Cleveland Drive Center
T: +1 216 901 2400
controltechniques.us@emerson.com

Detroit Application Center
T: +1 248 882 2652
controltechniques.us@emerson.com

Minneapolis Drive Center
Americas Headquarters
T: +1 952 995 8000
controltechniques.us@emerson.com

Portland Drive Center
T: +1 503 266 2094
controltechniques.us@emerson.com

Providence Application Center
T: +1 401 392 4256
controltechniques.us@emerson.com

LATIN AMERICA

Miami Application Center
T: +1 954 846 5082
saleslatinam.cta@emerson.com



The Emerson logo is a trademark and a service mark of Emerson Electric Co. ©2012 Emerson Electric Co.

DRIVING THE WORLD...

CONTROL TECHNIQUES DISTRIBUTORS

ARGENTINA
Euro Techniques SA
T: +54 11 4331 7820
eurotech@eurotechsa.com.ar

BAHRAIN
Emerson FZE
T: +971 4 8118100
ct.bahrain@emerson.com

BULGARIA
BLS - Automation Ltd
T: +359 32 630 707
info@blsaautomation.com

COLOMBIA
Sistronic SAS
T: +57 2 555 6000
luis.alvarez@sistronic.com.co

Redes Electricas S.A.
T: +57 1 364 7000
alvaro.rodriguez@redeselectricas.com

Quimel Colombia S.A.
T: +57 1 547 5215
gerencia@quimelco.com

CROATIA
Zigg-Pro d.o.o.
T: +385 1 3463 000
zigg-pro@zg.tnnet.hr

CYPRUS
Acme Industrial Electronic
Services Ltd
T: +3572 5 332181
acme@cytanet.com.cy

DOMINICAN REPUBLIC
Puradom S.A.
T: +1 809 565 9599
franco@puradom.com

EGYPT
Samiram
T: +202 29703868/
+202 29703869
samiramz@samiram.com

EL SALVADOR
Servielectric Industrial S.A. de C.V.
T: +503 2278 1280
aeorellana@gruposervielectric.com

ECUADOR
Veltek Cia. Ltda.
T: +59 3 2326 4623
vacosta@veltek.com.ec

FINLAND
SKS Control
T: +358 207 6461
control@sk.s.fi

GUATEMALA
MICE S.A.
T: +502 5510 2093
cesar.espana@miceautomation.com

HUNGARY
Control-VH Kft
T: +361 431 1160
info@controlvh.hu

ICELAND
Samey ehf
T: +354 510 5200
samey@samey.is

INDONESIA
PT. Apikon Indonesia
T: +65 6556 1100
controltechniques.sg@emerson.com

PT. Yusa Esa Sempurna Sejahtera
T: +65 6556 1100
controltechniques.sg@emerson.com

ISRAEL
Dor Drives Systems Ltd
T: +972 3900 7595
info@dor1.co.il

KENYA
Kassam & Bros Co. Ltd
T: +254 2 556 418
kassambros@africaonline.co.ke

KUWAIT
Emerson FZE
T: +971 4 8118100
ct.kuwait@emerson.com

LATVIA
EMT
T: +371 760 2026
janis@emt.lv

LEBANON
Black Box Automation
& Control
T: +961 1 443773
info@blackboxcontrol.com

LITHUANIA
Elinta UAB
T: +370 37 351 987
sales@elinta.lt

MALTA
Mekanika Limited
T: +35621 442 039
mfranca@gasan.com

MOROCCO
Cietec
T: +212 22 354948
cietec@cietec.ma

NEW ZEALAND
Advanced Motor Control. Ph.
T: +64 (0) 274 363 067
info.au@controltechniques.com

PERU
Intech S.A.
T: +51 1 348 5858
ventas@intech-sa.com

Tecno Ingeniería Industrial SAC
T: +51 1 445 3608
jforero@tecnoing.com

PHILIPPINES
Control Techniques Singapore Pte. Ltd.
T: +65 68917600
controltechniques.sg@emerson.com

POLAND
APATOR CONTROL Sp. z o.o.
T: +48 56 654 4900
info@acontrol.com.pl

PORTUGAL
Harker Sumner S.A.
T: +351 22 947 8090
drives.automation@harker.pt

PUERTO RICO
Motion Industries Inc.
T: +1 787 251 1550
roberto.diaz@motion-ind.com

Control Associates of Puerto Rico LLC
T: +1 (787) 783 9200
pr-sales@control-associates.com

QATAR
Emerson FZE
T: +971 4 8118100
ct.qatar@emerson.com

ROMANIA
C.I.T. Automatizari
T: +40212550543
office@citautomatizari.ro

SAUDI ARABIA
A. Abunayyan Electric Corp.
T: +9661 477 9111
acc-salesmarketing@
abunayyanguroup.com

SERBIA & MONTENEGRO
Master Inzenjering d.o.o.
T: +381 24 525 235
office@masterinzenjering.rs

SLOVENIA
PS Logatec
T: +386 1 750 8510
ps-log@ps-log.si

URUGUAY
SECIOIN S.A.
T: +5982 2093815
jose.barron@secioin.com.uy

VENEZUELA
Digimex Sistemas C.A.
T: +58 243 551 1634
digimex@digimex.com.ve

VIETNAM
Nguyen Duc Thinh Technology &
Trading Co. Ltd.
T: +84 8 3916 5601
infotech@nducthinh.com.vn

* Operated by sister company



© Control Techniques 2013. The information contained in this brochure is for guidance only and does not form part of any contract. The accuracy cannot be guaranteed as Control Techniques have an ongoing process of development and reserve the right to change the specification of their products without notice.